

ETU-LINK

Optical Communication System

SFP Series

SFP

ESDxx12-3LCD120

1.25Gbps DWDM 120KM SFP Transceiver

- Wavelength selectable to C-band ITU-T grid wavelengths
- Suitable for use in 100GHz channel spacing DWDM systems
- DWDM SFP MSA Compliant
- Dual data-rate of 1.25Gbps/1.063Gbps operation
- OC-24 120km range
- Up to 2.67Gb/s data rate
- Cold Start up Wavelength Compliance
- Low Power Dissipation <1.3W Maximum
- -5°C to 70°C Operating Case Temperature
- Diagnostic Performance Monitoring of module temperature, supply Voltages, laser bias current, transmit optical power, receive optical power, Laser temperature and TEC current
- Extended link budget with APD receiver technology
- RoHS compliant and lead free



Applications

- SFP Transceivers for DWDM SONET/ SDH
- Ethernet IEEE 802.3ae
- Fiber Channel

Description

ETU-Link DWDM SFP Transceiver exhibits excellent wavelength stability, supporting operation at 100GHz channel, cost effective module. It is designed for DWDM SONET/ SDH, Gigabit Ethernet and Fiber-Channel applications.

The transceiver consists of two sections: The transmitter section incorporates a cooled DFB laser. And the receiver section consists of an APD photodiode integrated with a TIA. All modules satisfy class I laser safety requirements. ETU-Link DWDM SFP transceiver provides an enhanced monitoring interface, which allows real-time access to device operating parameters such as transceiver temperature, laser bias current, transmitted optical power, received optical power and transceiver supply voltage, laser temperature and TEC current.

Pin Descriptions

Pin	Symbol	Name/Description	NOTE
1	VEET	Transmitter Ground (Common with Receiver Ground)	1
2	TFAULT	Transmitter Fault.	
3	TDIS	Transmitter Disable. Laser output disabled on high or open.	2
4	MOD_DEF(2)	Module Definition 2. Data line for Serial ID.	3
5	MOD_DEF(1)	Module Definition 1. Clock line for Serial ID.	3
6	MOD_DEF(0)	Module Definition 0. Grounded within the module.	3
7	Rate Select	No connection required	4
8	LOS	Loss of Signal indication. Logic 0 indicates normal operation.	5
9	VEER	Receiver Ground (Common with Transmitter Ground)	1
10	VEER	Receiver Ground (Common with Transmitter Ground)	1
11	VEER	Receiver Ground (Common with Transmitter Ground)	1
12	RD-	Receiver Inverted DATA out. AC Coupled	
13	RD+	Receiver Non-inverted DATA out. AC Coupled	
14	VEER	Receiver Ground (Common with Transmitter Ground)	1
15	VCCR	Receiver Power Supply	
16	VCCT	Transmitter Power Supply	
17	VEET	Transmitter Ground (Common with Receiver Ground)	1
18	TD+	Transmitter Non-Inverted DATA in. AC Coupled.	
19	TD-	Transmitter Inverted DATA in. AC Coupled.	
20	VEET	Transmitter Ground (Common with Receiver Ground)	1

Notes:

- 1) Circuit ground is internally isolated from chassis ground.
- 2) Laser output disabled on $T_{DIS} > 2.0V$ or open, enabled on $T_{DIS} < 0.8V$.
- 3) Should be pulled up with 4.7k - 10kohms on host board to a voltage between 2.0V and 3.6V. MOD_DEF (0) pulls line low to indicate module is plugged in.
- 4) This is an optional input used to control the receiver bandwidth for compatibility with multiple data rates (most likely Fiber Channel 1x and 2x Rates). If implemented, the input will be internally pulled down with $> 30k\Omega$ resistor. The input states are:

Low (0 – 0.8V): Reduced Bandwidth

(>0.8, < 2.0V): Undefined

High (2.0 – 3.465V): Full Bandwidth

Open: Reduced Bandwidth

- 5) LOS is open collector output should be pulled up with 4.7k - 10kohms on host board to a voltage between 2.0V and 3.6V. Logic 0 indicates normal operation; logic 1 indicates loss of signal.

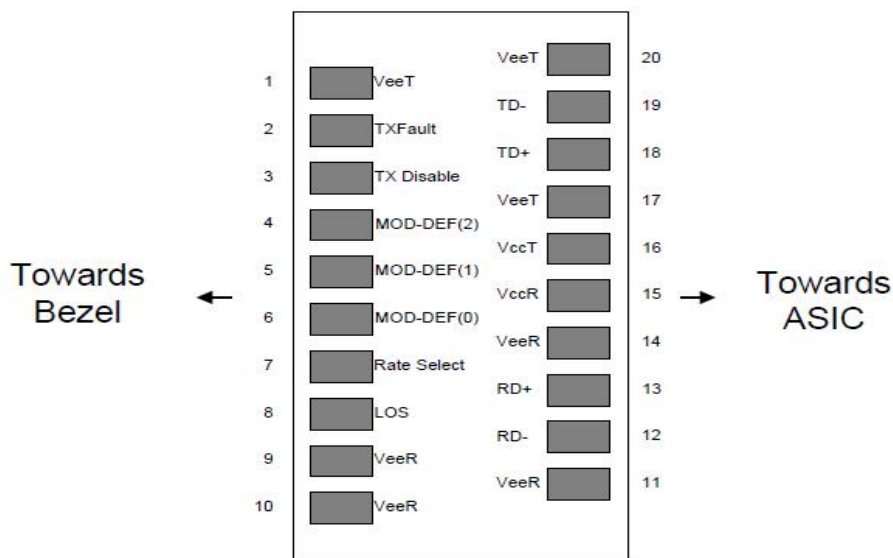

Figure2. Pin out of Connector Block on Host Board

Absolute Maximum Ratings

Parameter	Symbol	Min.	Typ.	Max.	Unit	Note
Storage Temperature	Ts	-40		85	°C	
Relative Humidity	RH	5		95	%	
Power Supply Voltage	VCC	-0.5		4	V	
Signal Input Voltage		-0.3		Vcc+0.3	V	
Receiver Damage Threshold		+5			dBm	

Recommended Operating Conditions

Parameter	Symbol	Min.	Typ.	Max.	Unit	Note
Case Operating Temperature	Tcase	0		70	°C	
Power Supply Voltage	VCC	3.13	3.3	3.47	V	
Power Supply Current	ICC			500	mA	
Power Supply Noise Rejection				100	mVp-p	100Hz to 1MHz
Data Rate			1250/1250		Mbps	TX Rate/RX Rate
Transmission Distance				120	KM	
Coupled Fiber		Single mode fiber			9/125um SMF	

Specification of Transmitter

Parameter	Symbol	Min.	Typ.	Max.	Unit	Note
Center Wavelength Spacing			100		GHz	
Center Wavelength	λ	X-100	X	X+100	pm	Note (1)
Average Output Power	POUT	0		5	dBm	
Extinction Ratio	ER	9			dB	
Side Mode Suppression Ratio	SMSR	30			dB	
Spectrum Bandwidth(-20dB)	σ			0.3	nm	
Transmitter OFF Output Power	POff			-45	dBm	
Differential Line Input Impedance	RIN	90	100	110	Ohm	
Output Eye Mask	Compliant with IEEE 802.3 Z					Note (2)

Note:

- 6) X = specified ITU center wavelength. (To See "Ordering Information")
 7) Transmitter eye mask definition.

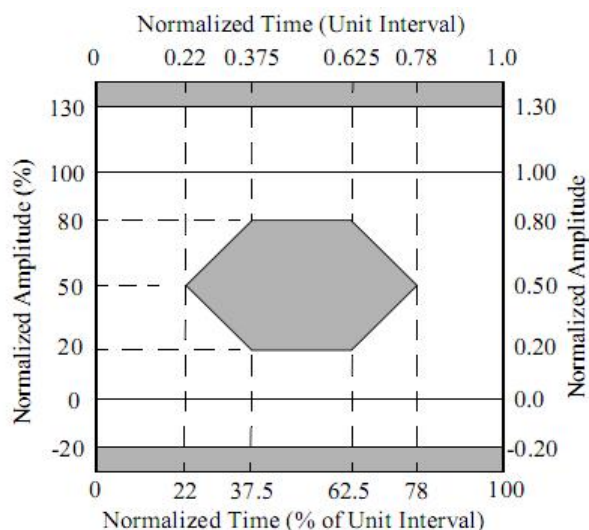

Specification of Receiver

Parameter	Symbol	Min.	Typ.	Max.	Unit	Note
Input Optical Wavelength	λ_{IN}	1270		1610	nm	APD
Receiver Sensitivity	PIN			-32	dBm	Note (1)
Input Saturation Power (Overload)	PSAT	-9			dBm	
Los Of Signal Assert	PA	-45			dBm	
Los Of Signal De-assert	PD			-36	dBm	Note (2)
LOS Hysteresis	PA-PD	0.5	2	6	dB	

Note:

- 8) Measured with Light source 1550nm, ER=9dB; BER = $<10^{-12}$ @PRBS=2²³-1 NRZ
- 9) When LOS de-asserted, the RX data+/- output is High-level (fixed)

Electrical Interface Characteristics

Parameter	Symbol	Min.	Typ.	Max.	Unit	Note
Transmitter						
Total Supply Current	ICC			A	mA	Note (1)
Transmitter Disable Input-High	VDISH	2		V _{cc} +0.3	V	
Transmitter Disable Input-Low	VDISL	0		0.8	V	
Transmitter Fault Input-High	VTxFH	2		V _{cc} +0.3	V	
Transmitter Fault Input-Low	VTxFL	0		0.8	V	
Receiver						
Total Supply Current	ICC			B	mA	Note (1)
LOSS Output Voltage-High	VLOSH	2		V _{cc} +0.3	V	LVTTTL
LOSS Output Voltage-Low	VLOSL	0		0.8	V	

Note:

- 10) A (TX) + B (RX) = 500mA (Not include termination circuit)

Digital Diagnostic Functions

ETU-LINK ESDXX12-3LCD120 transceivers support the 2-wire serial communication protocol as defined in the SFP MSA. It is very closely related to the E2PROM defined in the GBIC standard, with the same electrical specifications.

The standard SFP serial ID provides access to identification information that describes the transceiver's capabilities, standard interfaces, manufacturer, and other information.

Additionally, ETU-LINK SFP transceivers provide a unique enhanced digital diagnostic monitoring interface, which allows real-time access to device operating parameters such as transceiver temperature, laser bias current, transmitted optical power, received optical power and transceiver supply voltage. It also defines a sophisticated system of alarm and warning flags, which alerts end-users when particular operating parameters are outside of a factory set normal range.

The SFP MSA defines a 256-byte memory map in E2PROM that is accessible over a 2-wire serial interface at the 8 bit address 1010000X (A0h). The digital diagnostic monitoring interface makes use of the 8 bit address 1010001X (A2h), so the originally defined serial ID memory map remains unchanged. The interface is identical to, and is thus fully backward compatible with both the GBIC Specification and the SFP Multi Source Agreement.

The operating and diagnostics information is monitored and reported by a Digital Diagnostics Transceiver Controller (DDTC) inside the transceiver, which is accessed through a 2-wire serial interface. When the serial protocol is activated, the serial clock signal (SCL, Mod Def 1) is generated by the host. The positive edge clocks data into the SFP transceiver into those segments of the E2PROM that are not write-protected. The negative edge clocks data from the SFP transceiver. The serial data signal (SDA, Mod Def 2) is bi-directional for serial data transfer. The host uses SDA in conjunction with SCL to mark the start and end of serial protocol activation. The memories are organized as a series of 8-bit data words that can be addressed individually or sequentially.

Digital diagnostics for the ESDXX12-3LCD120 are internally calibrated by default.

Host - Transceiver Interface Block Diagram

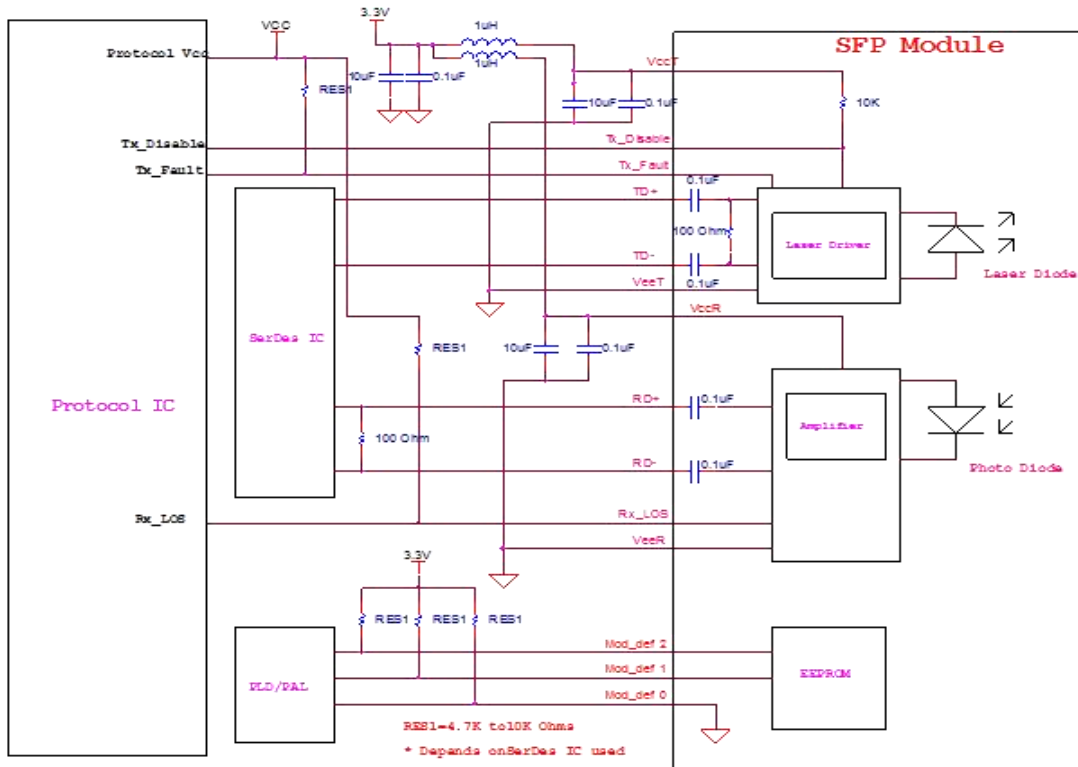

Outline Dimensions

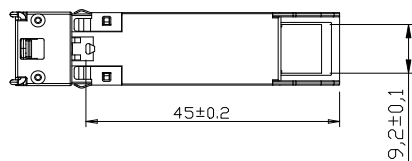
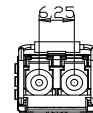
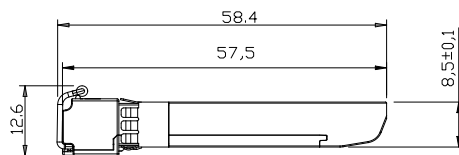
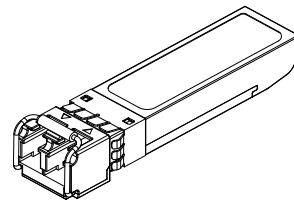
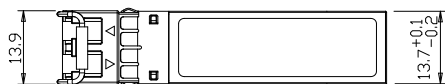

Units in mm

Regulatory Compliance

Feature	Reference	Performance
Electrostatic discharge (ESD)	IEC/EN 61000-4-2	Compatible with standards
Electromagnetic Interference (EMI)	FCC Part 15 Class B EN 55022 Class B (CISPR 22A)	Compatible with standards
Laser Eye Safety	FDA 21CFR 1040.10, 1040.11 IEC/EN 60825-1, 2	Class 1 laser product
Component Recognition	IEC/EN 60950, UL	Compatible with standards
ROHS	2002/95/EC	Compatible with standards
EMC	EN61000-3	Compatible with standards

Ordering Information

Code	Frequency (THz)	Center Wavelength(nm)	Code	Frequency (THz)	Center Wavelength(nm)
C17	191.7	1563.86	C40	194.0	1545.32
C18	191.8	1563.05	C41	194.1	1544.53
C19	191.9	1562.23	C42	194.2	1543.73
C20	192.0	1561.42	C43	194.3	1542.94
C21	192.1	1560.61	C44	194.4	1542.14
C22	192.2	1559.79	C45	194.5	1541.35
C23	192.3	1558.98	C46	194.6	1540.56
C24	192.4	1558.17	C47	194.7	1539.77
C25	192.5	1557.36	C48	194.8	1538.98
C26	192.6	1556.55	C49	194.9	1538.19
C27	192.7	1555.75	C50	195.0	1537.40
C28	192.8	1554.94	C51	195.1	1536.61
C29	192.9	1554.13	C52	195.2	1535.82
C30	193.0	1553.33	C53	195.3	1535.04
C31	193.1	1552.52	C54	195.4	1534.25
C32	193.2	1551.72	C55	195.5	1533.47
C33	193.3	1550.92	C56	195.6	1532.68
C34	193.4	1550.12	C57	195.7	1531.90
C35	193.5	1549.32	C58	195.8	1531.12
C36	193.6	1548.51	C59	195.9	1530.33
C37	193.7	1547.72	C60	196.0	1529.55
C38	193.8	1546.92	C61	196.1	1528.77
C39	193.9	1546.12			

Compatibility Test

In order to ensure the product compatibility, our products will be tested on the switch before shipment. Our modules can compatible with many mainstream brand switches, such as Cisco, Juniper, Extreme, Brocade, IBM, H3C, HP, Huawei, D-Link, Mikrotik, ZTE, TP-Link...

Our test equipment: VOLKTEK MEN-4110, HP 2530-8G, CRS226-24G-25+RM, Catalyst 2960G Series, Catalyst 3850 XS 10G SFP+, Catalyst 3750-E Series, HUAWEI S5700Series, H3C S3100V2 Series, Juniper-EX4200, etc.



Cisco Catalyst 3850



HUAWEI S5700



H3C S3100V2



HP J9264AR



Juniper EX 4200



Alcatel 6850E-U24X



Mikrotik CR5226-24G-25+RM



Cisco Catalyst 2960G



Volktek MEN-4110

Product Production Process

Quality Assurance

Continuous introduction of new equipment, produced by strict standards, strict quality inspection, to guarantee the high quality standard of each product.



**Standardized
Production Line**



**Professional
Welding**



Assembling



Aging Testing

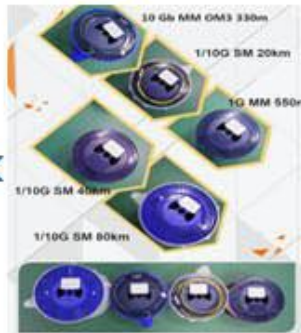

Distance Testing



Cleaning end face



Product Initial Test



Switch Testing



Product Final Test

Packaging

ETU-Link provides two kinds of packaging, 10pcs/Tray and individual package.



Company: ETU-Link Technology Co., LTD

Address: 4th Floor, C Building, JinBoLong Industrial Park, QingQuan Road, LongHua District, Shenzhen city, GuangDong

Tel: +86-755 2328 4603

Addresses and phone number also have been listed at www.etulinktechnology.com.

Please e-mail us at sales@etulinktechnology.com or call us for assistance.