

EB35(53)12-3D(I)-S

1.25Gbps SFP Bi-Directional 3km SFP Transceiver

PRODUCT FEATURES

- Dual data-rate of 1.25Gbps/1.063Gbps operation
- 1310nm FP laser and PIN photodetector for 3KM transmission
- 1550nm FP laser and PIN photodetector for 3KM transmission
- Compliant with SFP MSA and SFF-8472 with simplex SC receptacle
- Digital Diagnostic Monitoring:
Internal Calibration or External Calibration
- Compatible with SONET OC-24-LR-1
- Compatible with RoHS
- +3.3V single power supply
- Operating case temperature range:
0 °C to +70 °C (Commercial)
-40 °C to +85 °C (Industrial)

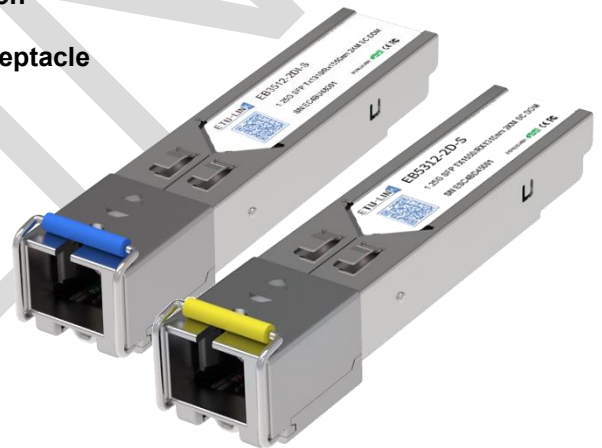

APPLICATIONS

- Gigabit Ethernet
- Fiber Channel
- Switch to Switch interface
- Switched backplane applications
- Router/Server interface
- Other optical transmission systems

DESCRIPTIONS

The SFP-BIDI transceivers are high performance, cost effective modules supporting dual data-rate of 1.25Gbps/1.0625Gbps and 3KM transmission distance with MMF.

The transceiver consists of three sections: a FP laser transmitter, a PIN photodiode integrated with a trans-impedance preamplifier (TIA) and control unit. All modules satisfy class I laser safety requirements.

The transceivers are compatible with SFP Multi-Source Agreement (MSA) and SFF-8472. For further information, please refer to SFP MSA.

Module Block Diagram

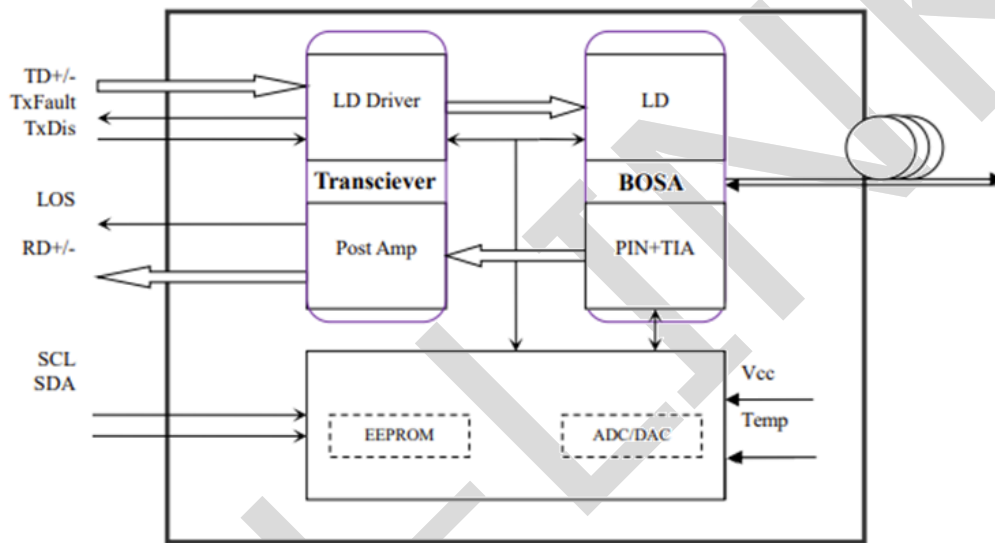

Ordering Information

Part No.	Data Rate(optical)	Laser	Fiber Type	Distance	Optical Interface	Temp	DDMI	Latch Color
EB3512-3D-S	1.25G	FP	SMF	3KM	SC	0~70°C	Y	Blue
EB5312-3D-S	1.25G	FP	SMF	3KM	SC	0~70°C	Y	Yellow
EB3512-3DI-S	1.25G	FP	SMF	3KM	SC	-40~85°C	Y	Blue
EB5312-3DI-S	1.25G	FP	SMF	3KM	SC	-40~85°C	Y	Yellow

Absolute Maximum Ratings

Parameter	Symbol	Min.	Typical	Max.	Unit	Notes
Maximum Supply Voltage	Vcc	-0.5		4.7	V	
Storage Temperature	TS	-40		85	°C	
Case Operating Temperature	TOP	0		70	°C	(Commercial)
Case Operating Temperature	TOP	-40		85	°C	(Industrial)

Recommended Operating Conditions

Parameter	Symbol	Min.	Typical	Max.	Unit	Notes
Case Operating Temperature	Top	0	-	70	°C	Commercial
		-40		85		Industrial
Power Supply Voltage	V _{CC}	3.13	3.3	3.47	V	
Transmission Distance	TD	-	-	3	km	Over SMF

Electrical Characteristics(TOP = -40 to 85°C, VCC = 3.15 to 3.60Volts)

Parameter	Symbol	Min.	Typical	Max.	Unit	Notes
Supply Voltage	V _{CC}	3.15	3.3	3.6	V	
Supply Current	I _{CC}		185	280	mA	
Transmitter (Module Input)						
Input differential impedance	R _{in}		100		Ω	1
Single ended data input swing	V _{in,pp}	250		1200	mV	
Transmit Disable Voltage	VD	V _{CC} -1.3		V _{CC}	V	
Transmit Enable Voltage	VEN	V _{EE}		V _{EE} + 0.8	V	2
Transmit Disable Assert Time				10	us	
Receiver (Module Output)						
Single ended data output swing	V _{out,pp}	250		800	mV	3
Data output rise time	t _r		100	260	ps	4
Data output fall time	t _f		100	260	ps	4
LOS Fault	V _{LOS fault}	V _{CC} -0.5		V _{CC} HOST	V	5
LOS Normal	V _{LOS norm}	V _{EE}		V _{EE} +0.5	V	5
Power Supply Rejection	PSR	100			mVpp	6

Notes:

1. Connected directly to TX data input pins. AC coupled thereafter.
2. Or open circuit.
3. Into 100 ohms differential termination.
4. 20 – 80 %
5. Loss Of Signal is LVTTTL. Logic 0 indicates normal operation; logic 1 indicates no signal detected.
6. Receiver sensitivity is compliant with power supply sinusoidal modulation of 20 Hz to 1.5 MHz up to specified value applied through the recommended power supply filtering network.

Optical and Characteristics

Parameter	Symbol	Min.	Typical	Max.	Unit	Notes
Transmitter						
Operating Wavelength	λC	1260	1310	1360	nm	EB3512-3D(I)-S
		1530	1550	1570		EB5312-3D(I)-S
Ave. output power (Enabled)	P _o	-9		-3	dBm	1

Extinction Ratio	ER	9			dB	1
RMS spectral width	$\Delta\lambda$			4	nm	
Rise/Fall time (20%~80%)	Tr/Tf			0.26	ps	2
Output Eye Mask	Compliant with IEEE802.3 z (class 1 laser safety)					
Receiver						
Operating Wavelength		1470 1260		1510 1360	nm	EB3512-3D(I)-S EB5312-3D(I)-S
Sensitivity	Psen			-20	dBm	3
Min. overload	Pimax	-3			dBm	
LOS Assert	Pa	-36			dBm	
LOS De-assert	Pd			-24	dBm	4
LOS Hysteresis	Pd-Pa	0.5		6	dB	

Notes:

1. Measure at 2⁷-1 NRZ PRBS pattern
2. Transmitter eye mask definition
3. Measured with Light source 1310nm (1550nm), ER=9dB; BER =<10⁻¹² @PRBS=2⁷-1 NRZ.
4. When LOS de-asserted, the RX data+/- output is signal output.

Digital Diagnostics

Parameter	Range	Accuracy	Unit	Calibration
Temperature	-40 to 85	±3	°C	Internal
Voltage	0 to Vcc	±3%	V	Internal
Tx Bias Current	0 to 100	±10%	mA	Internal
Tx Output Power	-3 to -9	±3	dB	Internal
Rx Input Power	-20 to -3	±3	dB	Internal

Pin Diagram

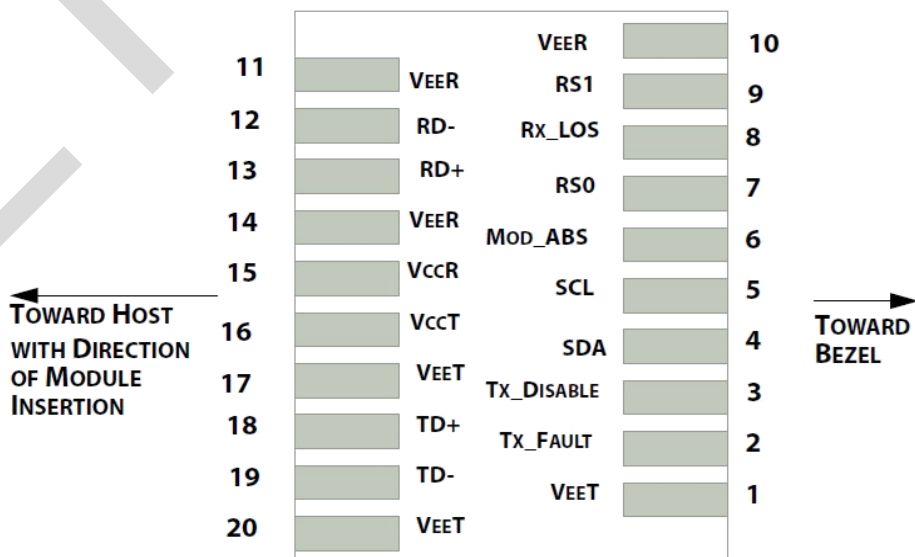

Pin Definitions

PIN #	Name	Function	Notes
1	VeeT	Tx ground	
2	Tx Fault	Tx fault indication, Open Collector Output, active "H"	1
3	Tx Disable	LVTTTL Input, internal pull-up, Tx disabled on "H"	2
4	MOD-DEF2	2 wire serial interface data input/output (SDA)	3
5	MOD-DEF1	2 wire serial interface clock input (SCL)	3
6	MOD-DEF0	Model present indication	3
7	Rate select	No connection	
8	LOS	Rx loss of signal, Open Collector Output, active "H"	4
9	VeeR	Rx ground	
10	VeeR	Rx ground	
11	VeeR	Rx ground	
12	RD-	Inverse received data out	5
13	RD+	Received data out	5
14	VeeR	Rx ground	
15	VccR	Rx power supply	
16	VccT	Tx power supply	
17	VeeT	Tx ground	
18	TD+	Transmit data in	6
19	TD-	Inverse transmit data in	6
20	VeeT	Tx ground	

Notes:

- When high, this output indicates a laser fault of some kind. Low indicates normal operation. And should be pulled up with a 4.7 – 10K Ω resistor on the host board.
- TX disable is an input that is used to shut down the transmitter optical output. It is pulled up within the module with a 4.7 – 10K Ω resistor. Its states are:
 Low (0 – 0.8V): Transmitter on (>0.8, < 2.0V): Undefined
 High (2.0V~Vcc+0.3V): Transmitter Disabled Open: Transmitter Disabled
- Mod-Def 0,1,2. These are the module definition pins. They should be pulled up with a 4.7K – 10K Ω resistor on the host board. The pull-up voltage shall be VccT or VccR.
 Mod-Def 0 has been grounded by the module to indicate that the module is present
 Mod-Def 1 is the clock line of two wire serial interface for serial ID
 Mod-Def 2 is the data line of two wire serial interface for serial ID
- When high, this output indicates loss of signal (LOS). Low indicates normal operation.
- RD+/-: These are the differential receiver outputs. They are AC coupled 100 Ω differential lines which should be terminated with 100 Ω (differential) at the user SERDES. The AC coupling is done inside the module and is thus not required on the host board.
- TD+/-: These are the differential transmitter inputs. They are AC-coupled, differential lines with 100 Ω differential termination inside the module. The AC coupling is done inside the module and is thus not required on the host board.

Recommended Interface Circuit

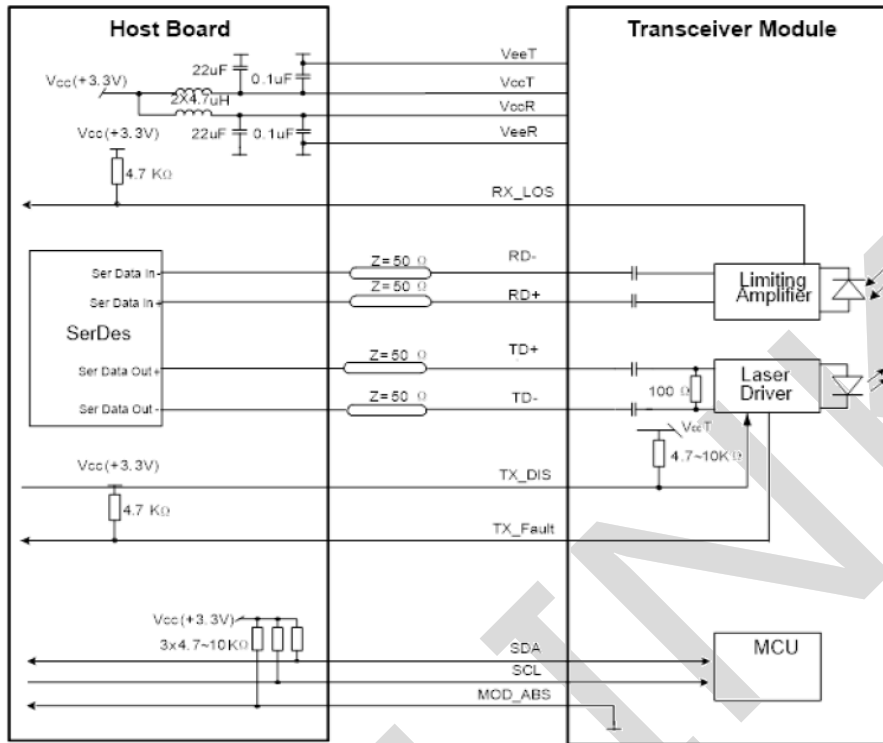

Mechanical Diagram

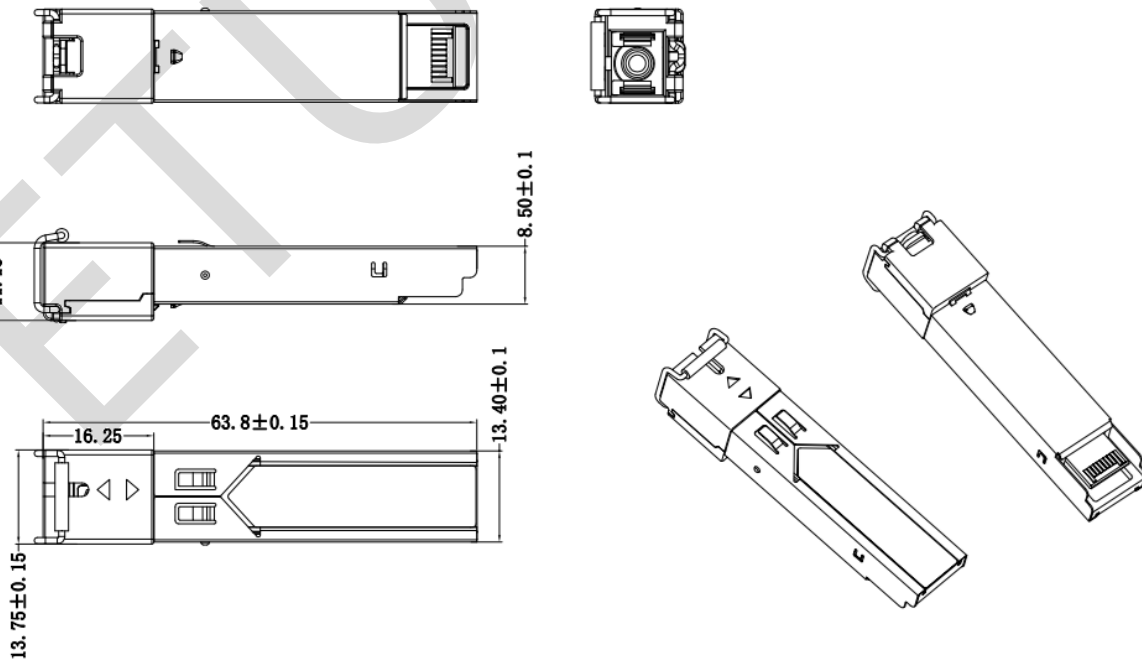

Revision History

Version No.	Date	Description
1.0	February 8, 2015	Preliminary datasheet
2.0	October 11, 2018	Product upgrades
3.0	Sep 02, 2024	Format change

Company: ETU-Link Technology Co., LTD

Production base: Right side of 3rd floor, No. 102 building, Longguan expressway, Dalang street, Longhua District, Shenzhen city, Guangdong Province, China 518109

R&D base: Floor 4, Building 4, Nanshan Yungu Phase LI, Taoyuan Community, Xili Street, Nanshan District, Shenzhen

Tel: +86-755 2328 4603

Addresses and phone number also have been listed at www.etulinktechnology.com.

Please e-mail us at sales@etulinktechnology.com or call us for assistance.