

Rev	Date	Modified by	Description
A0	2023		

Product Specifications

400Gbps OSFP56 Passive High Speed Cable

PN: EODP40X-330CNxx

Features

- Products Compliance with SFF-8636, OSFP_MSA
- Ethernet-Compliance with IEEE802.3cd
- Support 56G (PAM4) electrical data rates/channel
- Support I2C two - line string interface, easy to control
- Support for hot plugging
- Low crosstalk/Low power
- Maximum Link Length: up to 3m
- ROHS Compliance

Applications

- 400G Ethernet
- SWITCH/ Router
- Data storage and communication industry
- Data center, cloud server

Description

The 400G OSFP56 Passive Direct Attach Copper Twinax Cable is designed for use in 400GBASE Ethernet. OSFP56 is the module and cage/connector system based on current OSFP, targeting to support the 56Gb/s per lane speed in a 8x lane OSFP system and to enable the OSFP 400G interconnect ecosystem. This will greatly help the legacy OSFP users upgrade the link bandwidth to 400G per port with lower cost and shorter transition time.

Outline drawing

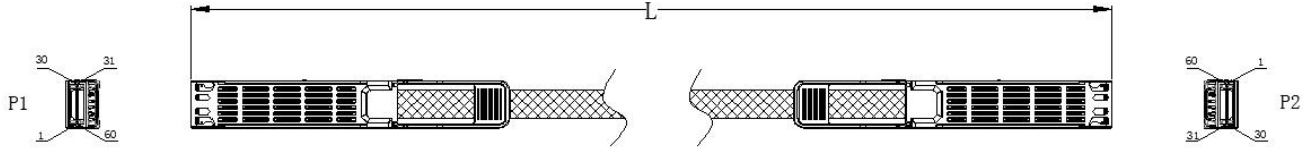

Wiring Diagram

P1			P2	
GND	1		31	GND
TX2+	2	↔	32	RX2+
TX2-	3	↔	33	RX2-
GND	4		34	GND
TX4+	5	↔	35	RX4+
TX4-	6	↔	36	RX4-
GND	7		37	GND
TX6+	8	↔	38	RX6+
TX6-	9	↔	39	RX6-
GND	10		40	GND
TX8+	11	↔	41	RX8+
TX8-	12	↔	42	RX8-
GND	13		43	GND
SCL	14		44	INT/RSTn
VCC	15		45	VCC
VCC	16		46	VCC
LPWh/PRSn	17		47	SDA
GND	18		48	GND
RX7-	19	↔	49	TX7-
RX7+	20	↔	50	TX7+
GND	21		51	GND
RX5-	22	↔	52	TX5-
RX5+	23	↔	53	TX5+
GND	24		54	GND
RX3-	25	↔	55	TX3-
RX3+	26	↔	56	TX3+
GND	27		57	GND
RX1-	28	↔	58	TX1-
RX1+	29	↔	59	TX1+
GND	30		60	GND

P1			P2	
GND	31		1	GND
RX2+	32	↔	2	TX2+
RX2-	33	↔	3	TX2-
GND	34		4	GND
RX4+	35	↔	5	TX4+
RX4-	36	↔	6	TX4-
GND	37		7	GND
RX6+	38	↔	8	TX6+
RX6-	39	↔	9	TX6-
GND	40		10	GND
RX8+	41	↔	11	TX8+
RX8-	42	↔	12	TX8-
GND	43		13	GND
INT/RSTn	44		14	SCL
VCC	45		15	VCC
VCC	46		16	VCC
SDA	47		17	LPWh/PRSn
GND	48		18	GND
TX7-	49	↔	19	RX7-
TX7+	50	↔	20	RX7+
GND	51		21	GND
TX5-	52	↔	22	RX5-
TX5+	53	↔	23	RX5+
GND	54		24	GND
TX3-	55	↔	25	RX3-
TX3+	56	↔	26	RX3+
GND	57		27	GND
TX1-	58	↔	28	RX1-
TX1+	59	↔	29	RX1+
GND	60		30	GND

PINOUT

Top Side (viewed from top)

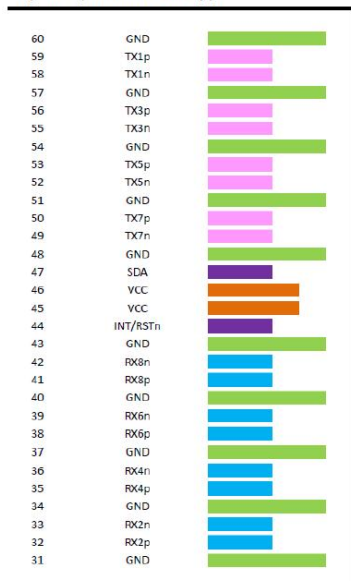

Bottom Side (viewed from bottom)

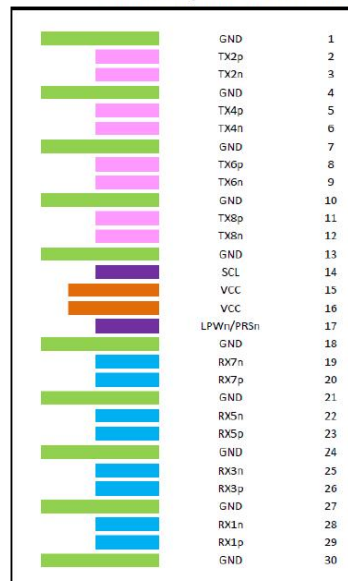

Module Card Edge

Electrical Performance

Signal Integrity

ITEM		REQUIREMENT	TEST CONDITION
(Differential Impedance)	Cable Impedance	$100 \pm 5\Omega$	Rise time of 25ps (20% - 80%).
	Paddle Card Impedance	$100 \pm 10\Omega$	
	Cable Termination Impedance	$100 + 10/-15\Omega$	
[Differential (Input/Output) Return loss S_{DD11}/S_{DD22}]	$\text{Return_loss}(f) \geq \begin{cases} 16.5 - 2\sqrt{f} & 0.05 \leq f < 4.1 \\ 10.66 - 14 \log_{10}(f/5.5) & 4.1 \leq f \leq 19 \end{cases}$ Where f is the frequency in GHz Return loss(f) is the return loss at frequency f	$10\text{MHz} \leq f \leq 26.5\text{GHz}$	
[Differential to common-mode (Input/Output) Return loss S_{CD11}/S_{CD22}]	$\text{Return_loss}(f) \geq \begin{cases} 22 - 10(f/25.78) & 0.05 \leq f < 12.89 \\ 15 - (6/25.78)f & 12.89 \leq f \leq 19 \end{cases}$ Where f is the frequency in GHz Return_loss(f) is the Differential to common-mode return loss at frequency f	$50\text{MHz} \leq f \leq 26.5\text{GHz}$	
[Common-mode to Common-mode (Input/Output) Return loss S_{CC11}/S_{CC22}]	$\text{Return_loss}(f) \geq 2\text{dB} \quad 0.05 \leq f \leq 19$ Where f is the frequency in GHz Return_loss(f) is the common-mode to common-mode return loss at frequency f	$50\text{MHz} \leq f \leq 26.5\text{GHz}$	
[Differential Insertion Loss (S_{DD21} Max.)]	(Differential Insertion Loss Max. For TPa to TPb Excluding Test fixture)		$50\text{MHz} \leq f \leq 26.5\text{GHz}$
	$\text{Insertion_loss}(f) \geq -17.16\text{dB} \quad 0.05 \leq f \leq 13.28\text{GHz}$ Where f is the frequency in GHz Insertion Loss (f) Differential Insertion Loss at frequency f		
[Insertion Loss Deviation]	$-0.176 * f - 0.7 \leq \text{ILD} \leq 0.176 * f + 0.7$		$50\text{MHz} \leq f \leq 26.56\text{GHz}$
Differential to common-mode Conversion Loss-Differential Insertion	$\text{Conversion_loss}(f) - \text{IL}(f) \geq \begin{cases} 10 & 0.05 \leq f < 12.89 \\ 14 - 0.3108f & 12.89 \leq f < 26.5 \end{cases}$ Where f is the frequency in GHz	$50\text{MHz} \leq f \leq 26.5\text{GHz}$	

Loss($S_{CD21}-S_{DD21}$)	Conversion_loss(f) is the cable assembly differential to common-mode conversion loss IL(f) is the cable assembly insertion loss	
[MDNEXT(multiple disturber near-end crosstalk)]	$\geq 35\text{dB @}26.5\text{GHz}$	$10\text{MHz} \leq f \leq 26.5\text{GHz}$
[Intra Skew]	10ps/m,	$10\text{MHz} \leq f \leq 19\text{GHz}$

Other Electrical Performance

ITEM	REQUIREMENT	TEST CONDITON
[Low Level Contact Resistance]	70milliohms Max. From initial.	EIA-364-23:Apply a maximum voltage of 20mV And a current of 100 mA.
Insulation Resistance	10Mohm(Min.)	EIA364-21:AC 300V 1minute
[Dielectric Withstanding Voltage]	NO disruptive discharge.	EIA-364-20:Apply a voltage of 300 VDC for 1minute between adjacent terminals And between adjacent terminals and ground.

Environment Performance

ITEM	REQUIREMENT	TEST CONDITON
[Operating Temp. Range]	0°C to +70°C	Cable operating temperature range.
[Storage Temp. Range (in packed condition)]	-40°C to +80°C	Cable storage temperature range in packed condition.
[Thermal Cycling Non-Powered]	No evidence of physical damage	EIA-364-32D, Method A, -25 to 90C, 100 cycles, 15 min. dwells
[Salt Spraying]	48 hours salt spraying after shell corrosive area less than 5%.	EIA-364-26
Mixed Flowing Gas	Pass electrical tests per 3.1 after stressing. (For connector only)	EIA-364-35 Class II, 14 days.
Temp. Life	No evidence of physical damage	EIA-364-17C w/ RH, Damp heat 90°C at 85% RH for 500 hours then return to ambient
Cable Cold Bend	4H, No evidence of physical damage	Condition: -20°C±2°C, mandrel diameter is 6 times the cable diameter.

Mechanical and Physical Characteristics

ITEM	REQUIREMENT	TEST CONDITON
Vibration	Pass electrical tests per 3.1 after stressing.	Clamp & vibrate per EIA-364-28E, TC-VII, test condition letter – D, 15 minutes in X, Y & Z axis.
Cable Flex	No evidence of physical damage	Flex cable 180° for 20 cycles ($\pm 90^\circ$ from nominal position) at 12 cycles per minute with a 1.0kg load applied to the cable jacket. Flex in the boot area 90° in each direction from vertical. Per EIA-364-41C
Cable Plug Retention in Cage	125 N Min. No evidence of physical damage	No functional damage to module, connector, or cage with latching mechanism activated. Per OSFP_Specification_Rev5_0 5.0
Cable Retention in Plug	90N Min. No evidence of physical damage	Cable plug is fixtured with the bulk cable hanging vertically. A 90N axial load is applied (gradually) to the cable jacket and held for 1 minute. Per EIA-364-38B
Mechanical Shock	Pass electrical tests Per 3.1 after stressing.	Clamp and shock per EIA-364-27B, TC-G,3 times in 6 directions, 100g, 6ms.
Cable Plug Insertion	40N Max.(55N)	Per OSFP_Specification_Rev5_0 5.0 Module to be inserted into connector and cage with latch mechanism engaged. (55N if the cage has riding heatsink)
Cable plug Extraction	30N Max. (45N)	Per OSFP_Specification_Rev5_0 5.0 Module to be removed from connector and cage with latching mechanism disengaged. (45N if the cage has riding heatsink)
Durability	Module:50 cycles, Connector/Cage Cycles : 100 cycles No evidence of physical damage	Per OSFP_Specification_Rev5_0 5.0, Number of cycles for an individual module, to be tested with cage, connector, and module; latches may be locked out during testing

Ordering Information

PN	Data Rate	Length	Wire Gauge	Temp.Range	Note
EODP40X-330CN0	400G	0.5M	30AWG	0-70° C	
EODP40X-330CN1	400G	1M	30AWG	0-70° C	
EODP40X-328CN1.5	400G	1.5M	28AWG	0-70° C	
EODP40X-328CN2	400G	2M	28AWG	0-70° C	
EODP40X-327CN3	400G	3M	27AWG	0-70° C	

Compatibility Test

In order to ensure the product compatibility, our products will be tested on the switch before shipment. Our modules can compatible with many mainstream brand switches, such as Cisco, Juniper, Extreme, Brocade, IBM, H3C, HP, Huawei, D-Link, Mikrotik, ZTE, TP-Link...

Our test equipment: VOLKTEK MEN-4110, HP 2530-8G, CRS226-24G-25+RM, Catalyst 2960G Series, Catalyst 3850 XS 10G SFP+, Catalyst 3750-E Series, HUAWEI S5700Series, H3C S3100V2 Series, Juniper-EX4200, etc.



HUAWEI S6720S

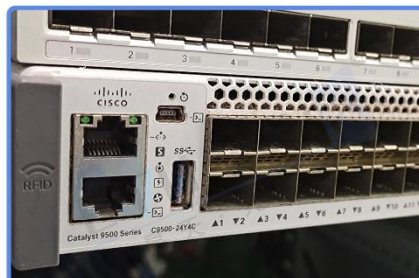

CISCO Catalyst 9500



DELL S5048F



H3C S3100V2

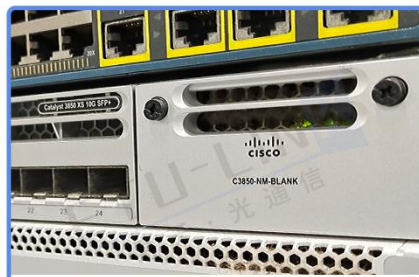

CISCO C3850



Aruba 2930F



Juniper EX 4200



HP J9264A

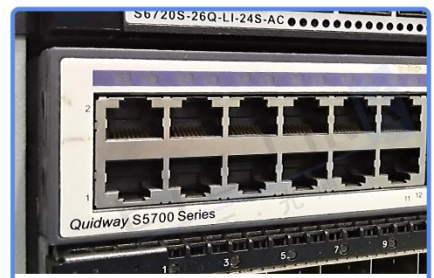

Quidway S5700

Product Production Process

Quality Assurance

Continuous introduction of new equipment,
produced by strict standards, strict quality inspection,
to guarantee the high quality standard of each product.

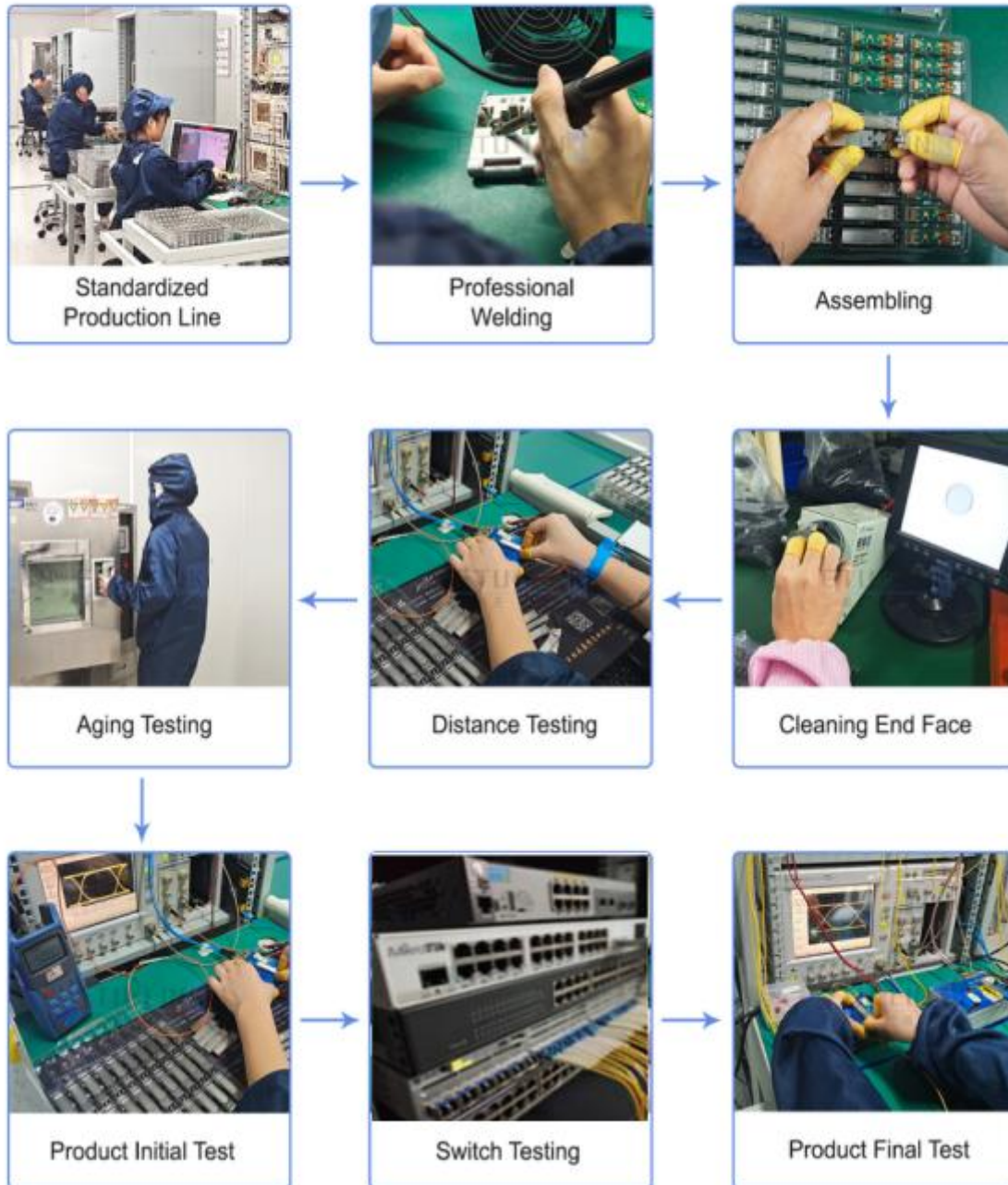

Package diagram

Both ends of the connector use protective sleeve protection, each into a separate anti - static bag.

<=2m : 300*350mm

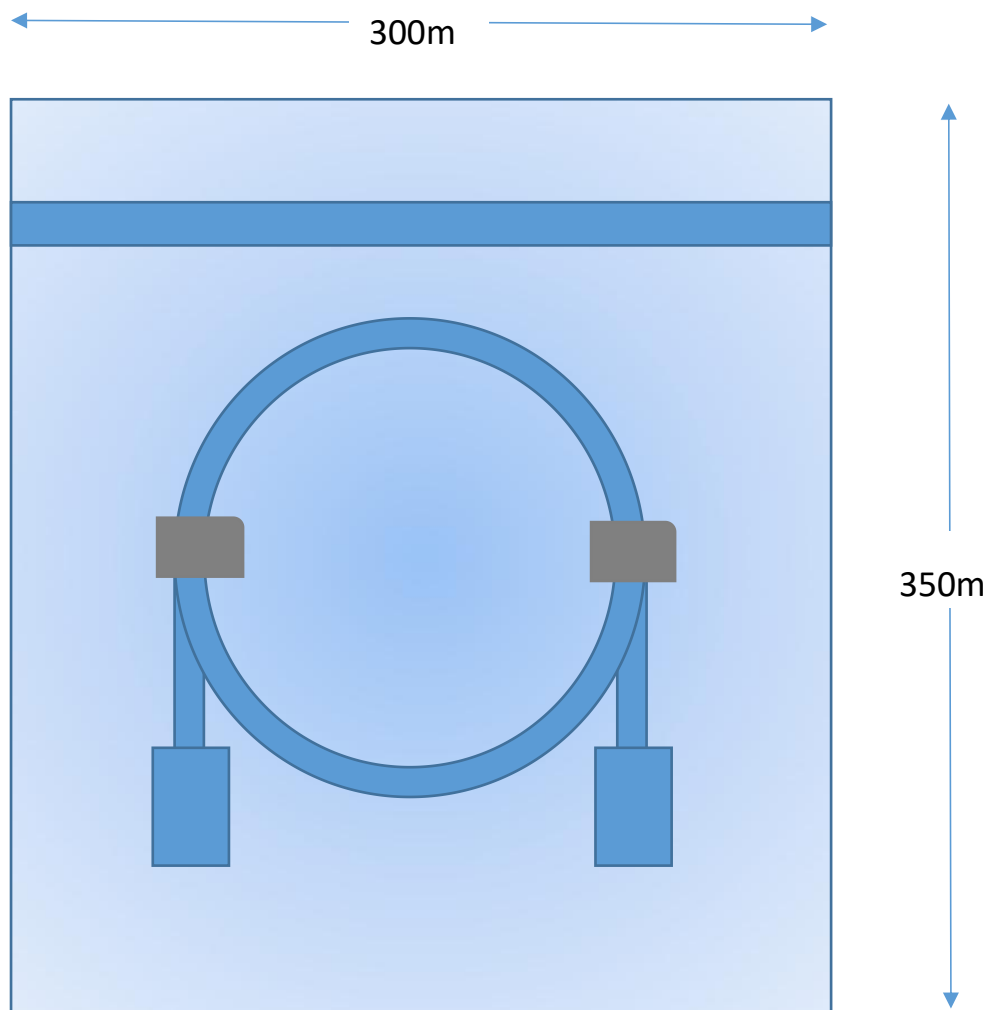

Company: ETU-Link Technology Co., LTD

Address: Right side of 3rd floor, No. 102 building, Longguan expressway, Dalang street,
Longhua District, Shenzhen city, Guangdong Province, China 518109

Tel: +86-755 2328 4603

Addresses and phone number also have been listed at www.etulinktechnology.com.

Please e-mail us at sales@etulinktechnology.com or call us for assistance.